







# CONDOR® PIT-STOP / TRAILER-STOP USER INSTRUCTION MANUAL

## **STOP! WARNING: READ THIS FIRST!**

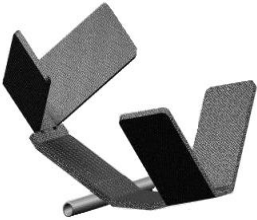
First Read and Understand the Instruction manual and product labels for important safety, set-up and troubleshooting information. If you have problems setting up or using the Condor® Pit-Stop, contact customer service @ 1-815-754-7418 or contact us via e-mail @ [www.condor-lift.com](http://www.condor-lift.com). The Condor® Pit-Stop is not intended for use by children.

**Assembly Instructions:** Remove all parts from shipping box. Check the parts below to make sure you have all the parts needed to assemble your Condor® Pit-Stop before beginning. In the unlikely event that you find a part damaged or missing, please call customer service @ #1-815-754-7418.

Parts	Key	Qty.	Description
	A	1	Condor® Main Unit
	B	1	Condor® Front Base Support Bar
	C	1	Condor® Standard Maximum Retention Cradle (P-Cradle-C)
	D	2	5/16" - 18 x 3/4" Flat Head Socket Cap Screw (P-94254)
	E	1	1/2" x 10" Front Stop Pin w/ Hitch Pin Clip 11 (Z118)
	F	1	3/8" x 10" Cradle Pin w/ Hitch Pin Clip 16 (Z101)

### **Assembly Illustration:**

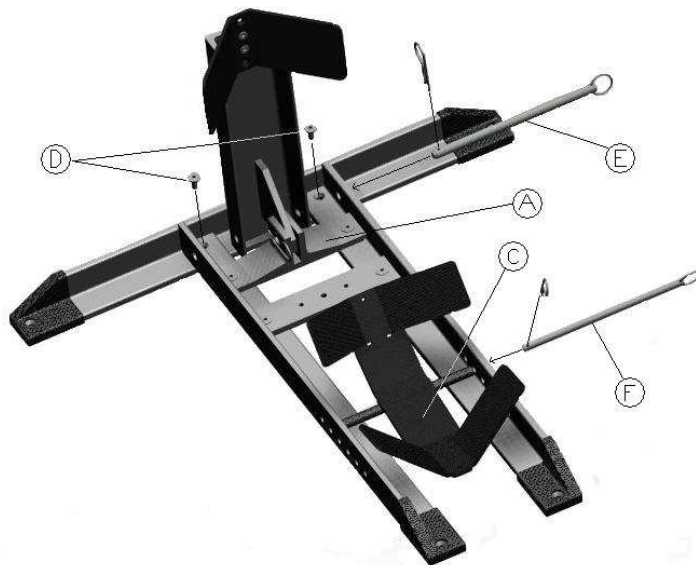

Step1: Using screws (D), attach the Base Bar (B) to the Main Unit (A). (3/16 allen wrench required, torque between 16 - 18 ft-lbs)

Step2: Swing the Front Stop containing the CONDOR® logo into position.

Step3: Place Pin (E) through Main Unit and Front Stop Channel. The pin may be tight at first use, push it through using light force and twisting it in. (Attach Hitch Pin Clip once the pin has passed all the way through.)

Step4: Place Cradle (C) as shown in the desired setting and insert Pin (F) through Main unit and cradle pipe. (Attach Hitch Pin Clip once the pin has passed all the way through.)

**Warning: Only use unit when properly assembled.**

### **User Instructions:**

Confirm that the cradle is set in the optimized position setting (See RECOMMENDED CRADLE SETTINGS) for the entering tire and wheel. Adjustment of cradle is crucial for optimum retention. Optimum retention is achieved by trying different settings. (REFER TO CAUTION PARAGRAPH BELOW): Place unit in front of or behind motorcycle. Push or drive the motorcycle, centered into unit until the cradle of the Pit-Stop has fully engaged the wheel. Once the wheel is cradled, proceed to push further into the Pit-Stop until the wheel has engaged the front stop. If the optimum vertical support is achieved, the motorcycle will hold itself upright. If optimum retention is not achieved try different cradle settings. (REFER TO CAUTION PARAGRAPH BELOW): As an extra precaution, one may use an optional bungee cord to strap the cradled wheel to the front stop. (Optional bungee cord purchased separately.) Strap bungee, if purchased, through the wheel and around the front stop below the upper front stop flange. For more information on use, refer to [www.condor-lift.com](http://www.condor-lift.com)

### **RECOMMENDED CRADLE SETTINGS:**

The Condor Pit-Stop/Trailer-Stop is designed so that for every tire/wheel size within the ranges specified a minimum of 2 cradle settings is suitable.

**\*\*\*The optimum cradle setting for a specific tire would be the setting that allows the cradle to tilt as far forward as possible without making contact with the unit's mounting surface or ground.\*\*\***

The 2<sup>nd</sup> optimum setting would be the setting forward from the optimum setting away from the entry direction. If less retention is desired at any time due to too much retention or sticking, the cradle may be moved away from the entry direction one notch.

### **RACING APPLICATIONS:**

For bikes with GP or low durometer front tire compounds, use the 6<sup>th</sup> and 5<sup>th</sup> cradle setting from the entry directions. For hot sticking tires use the 6<sup>th</sup> setting.

### **CAUTION:**

Always make sure that all fasteners are tight and all pins are in place prior to use. Understand the limitations of this product and do not exceed these limitations. Always make sure that the unit's cradle settings are optimum for the tire size of the motorcycle before use. For standard sport bike front wheel combinations, the 1, 2, 3, front settings may be suitable. If instructions are not clear, additional information is available at [www.condor-lift.com](http://www.condor-lift.com) or call 1-800-461-1344. Technical Components Development & Design is not responsible for any damage incurred by exceeding this product's limitations in structure and/or functionality.

### **One Year Limited Warranty:**

This Condor® Pit-Stop product warranty extends to the original consumer purchaser of the product. All illustrations and specifications contained in this manual are based on the latest product information available at the time of printing. Technical Components Development & Design, Inc. reserves the right to make changes at any time, without notice, in color, materials, equipment, options, specifications and models. Models may be shown with optional equipment. Further information may be obtained by contacting Technical Components Development & Design, Inc. @ #1-815-754-7418.

### **Warranty Duration:**

This product is warranted to the original consumer purchase for a period of one (1) year from original purchase date.

### **What is not covered:**

Our warranty for your product will not cover abnormal wear of parts, damage resulting from negligent use or misuse of the product, use contrary to operating instructions, or disassembly, repair or alteration by any person other than an authorized service station. We shall not be liable for any incidental or consequential damages for breach of by express or implied warranty on your product.

### **Return Policy:**

15 day return policy applies. Merchandise may be returned within 15 days of purchase. Merchandise must be unused and in its original packaging. Customer will call TC Development for a Return Authorization number. Customer pays for freight return. Credit is given upon inspection of returned goods. A 15% re-stocking fee applies to all returned merchandise.

### **How your state's law may apply:**

Some states do not allow limitations on how long any implied warranty lasts or the exclusion or limitation of incidental or consequential damages. So the above limitation may not apply to you. This warranty gives you specific legal rights, and you may also have other rights, which may vary from state to state.

**Thank you for purchasing the Condor Pit-Stop/Trailer-Stop.**

Patent Number: RE 42,735

**Condor® is a trademark of Technical Components Development & Design, Inc.**

**The Condor Pit-Stop / Trailer-Stop is US Patented & International Patent Pending.**

210 W. Stephenie Drive

Cortland, IL 60112

Phone: (815) 754-7418

Fax: (815) 754-7419

Web Site: [www.condor-lift.com](http://www.condor-lift.com)