

LOW-RISED PORTABLE LIFT

The Portable low-rised lift is an excellent choice for low ceiling or adding a bay for seasonal increases in business. Provides good working height for tires, brakes and body repairs.



LR06

Main Features

- ✓ Multiple safety locks with mechanical release.
- ✓ Portable, Easy to move with power unit stand.
- ✓ High speed: From 105-600 mm (4 1/8"-23 5/8") in just 25 seconds.
- ✓ High density rubber pads included.



Rubber Lift Pads 1 1/2" height.



Multiple safety locks with mechanical release.

SPECIFICATIONS

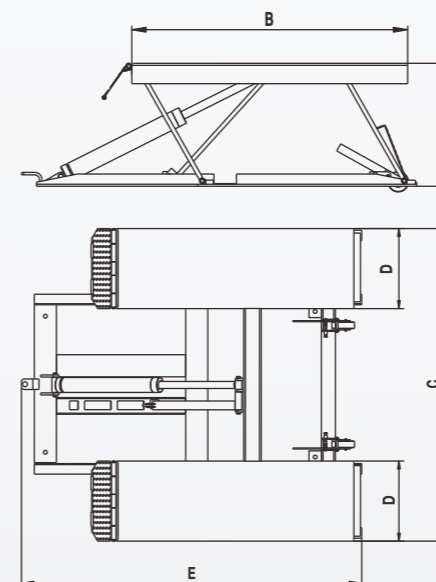

Model	LR06
Lifting Capacity	6,000lbs (2800kg)
Lifting Time	25S
Lifting Height	A1 23 5/8" (600mm)
Minimum Height	A2 4 1/8" (105mm)
Runway Length	B 53 1/4" (1352mm)
Overall Width	C 70" (1780mm)
Runway Width	D 18" (456mm)
Overall Length	E 76 1/4" (1938mm)
Gross Weight	811lbs (368kg)
Motor	1.0HP,110V/60Hz,single phase

AMGO HYDRAULIC CORPORATION

1931 Joe Rogers Jr Blvd, Manning, SC 29102, USA
Tel:(803)505-6410 www.amgohyd.com